Stackable Battery Pack

Pack Installation & Operation Manual

- BR-BOX-LV 5KWH
- BR-BOX-LV 10KWH
- BR-BOX-LV 20KWH
- BR-BOX-LV 30KWH



Content

1. Preface	01
2. Label Explanation	02
3. Product Description	02
4. Product Advantages	03
5. Product Technical Parameters	03
• 5.1 Product Appearance	04
• 5.2 Specification	04
• 5.3 Interface Overview	05
• 5.4 Battery Management System	06
• 5.4.1 Overcharge Protection	06
• 5.4.2 Overdischarge Protection	06
• 5.4.3 Overcurrent Protection	06
• 5.4.4 Over Temperature Protection	06
• 5.4.5 Low Temperature Protection	06
6. Installation and Configuration	07
• 6.1 Packing	07
• 6.2 Recommended Tools	08
• 6.3 Notice for Installation	08
7. Connection	10
• 7.1 Precautions Before Connecting The Inverter	10
• 7.2 Pin definition	11
• 7.3 Dip Code Switch Definition and Setting	12
8. Operation	14
• 8.1 Check Before Power on	14
• 8.2 Power on	14
9. Operation of Upper System	15
• 9.1 Log in	16
• 9.2 Operation of The Communication Protocol Switch	17
• 9.3 Communication Compatible List	18
10. Storage	19
11. Warning	19

1. Preface

This manual will provide detailed product information and installation instructions for users of the wall-mounted series products of SHENZHEN BASENGREEN TECHNOLOGY CO.LTD (hereinafter referred to as BASENGREEN). Please read this manual carefully, and put this manual in a place where you can install, operate, and obtain it conveniently.

The safety precautions mentioned in the manual do not represent all the safety matters that should be observed, but are only supplementary to the safety precautions. When installing, operating, and maintaining equipment, local safety regulations and norms should be followed. Only trained professionals can install, operate and maintain equipment. Our company does not assume any responsibility for losses caused by violation of general safety operation requirements or violation of safety standards for the design, production, and use of equipment. Installation and maintenance personnel must have high-voltage and AC power operation skills. When installing, operating, and maintaining equipment, they must not wear any conductive objects, such as watches, bracelets, bracelets, and rings, and prevent moisture from entering the equipment.



Safety Instructions

High Voltage Danger

The high-voltage power supply provides power for the operation of the equipment. Direct contact or indirect contact with high-voltage power supply through wet objects will cause fatal danger.

Use Professional Tools

Always use professional tools instead of personal tools when working with high voltage and AC power

Anti-static

The static electricity generated by the human body will damage the electrostatic sensitive components on the board. Before touching the plug-in, circuit board or chip, make sure to take proper anti-static measures.

Operate Attention

The power must be cut off first before operation, do not hot-line work.

DC short circuit Danger

The power system provides a DC-regulated power supply, and a DC short circuit will damage the equipment and cause personal injury.

2. Label Explanation

The label contains the following information



Guangdong Basengreen New Energy Co.,Ltd

Product Name	Rechargeable LiFePO4 Battery
Product Model	BR-BOX-LV 5KWH
Battery Voltage Operation Range	43.2Vdc-58.4Vdc
Maximum Charge Current	100A
Maximum Discharge Current	100A
Rated Capacity	100Ah/51.2V/5120Wh
Ingress Protection	IP55
Protective Class	1

SN: CE UN38.3











⚠ DANGER
 DANGER LOW DC VOLTAGE INSIDE
 DANGER ARC FLASH & SHOCK HAZARD

-  · Do not disconnect or disassemble by non-professional personnel.
-  · Do not drop, deform, hit or pierce with sharp objects.
-  · Do not place at a children or pet touchable area.
-  · Do not place near open flame or flammable material.
-  · Do not cover or wrap the product case.
-  · Do not sit or put any object on battery.
-  · Avoid direct sunlight.
-  · Avoid moisture or liquid.
-  · The product ingress Protection (IP) class is IP55.
-  · Make sure the grounding connection is correct before operation.
-  · Follow the product manual to make wiring connection.
-  · If leaking, fire, wet or damaged, switch off the breaker on DC side and stay away from battery. Do not touch the leaking liquid.
-  · Contact your supplier within 24 hours if any failure happens.

3. Product Description

This product is a lithium iron phosphate battery (LFP LiFePO4) composed of 16 cells in series. Which is suitable for home energy storage systems. It can be customized according to customer needs to meet diverse application scenarios and provide stable power for various equipment of users.

4. Product Advantages

- a. Built-in Battery Management System (BMS): Overcharge, overdischarge, overcurrent, temperature control, short circuit and other protection functions.
- b. Passive Balance Function: There is a voltage equalization function during the charging.
- c. High Cost Performance: High safety performance, long service life, stable and reliable quality.
- d. Expandable: Equipped with RS232/ RS485/ CAN bus ports, support up to 15 units in parallel.
- e. Wide Working Temperature: -20°C to 60°C , excellent high-temperature discharge performance.
- f. Convenient: Modular design, small size and lightweight, easy to install and maintain.

5. Product Technical Parameters

5.1 Product Appearance

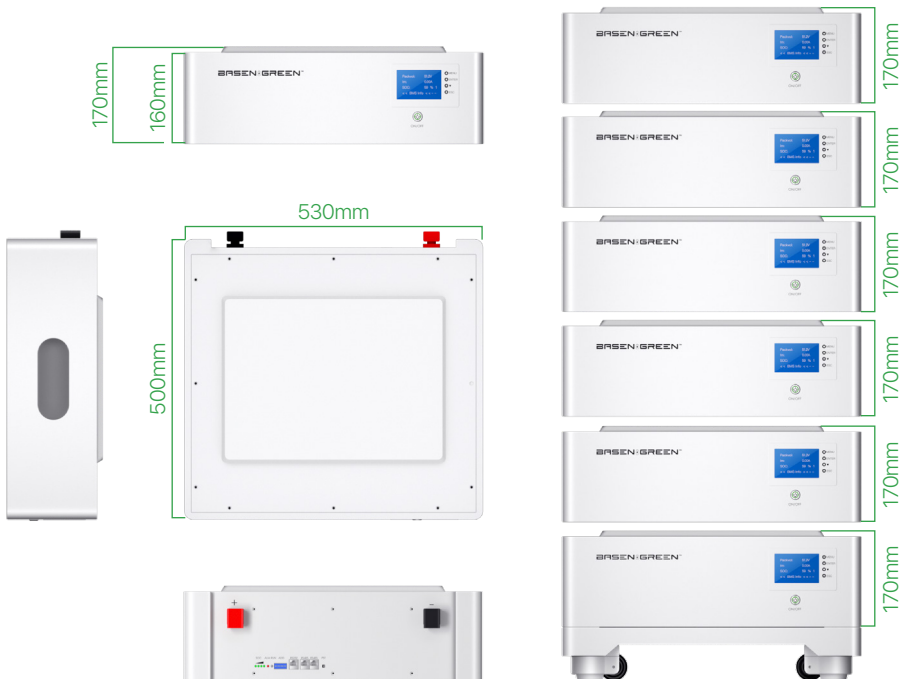

5.2 Specifications

Item	Specifications			
Model	BR-BOX-LV 5KWH	BR-BOX-LV 10KWH	BR-BOX-LV 20KWH	BR-BOX-LV 30KWH
Nominal Voltage	51.2V	51.2V	51.2V	51.2V
Operating Voltage	43.2V-57.6V	43.2V-57.6V	43.2V-57.6V	43.2V-57.6V
Nominal Capacity	100Ah	200Ah	400Ah	600Ah
Total Energy	5120Wh	10240Wh	20480Wh	30720Wh
Configuration	1P16S	(1P16S)*2	(1P16S)*4	(1P16S)*6
Charging Cut-off Voltage	58.4V	58.4V	58.4V	58.4V
Discharge Cut-off Voltage	43.2V	43.2V	43.2V	43.2V
Operation Temperature	-20℃~60℃	-20℃~60℃	-20℃~60℃	-20℃~60℃
Standard Charging Current	20A	40A	80A	100A
Max Continuous Charging Current	100A	100A	100A	100A
Max Continuous Discharge Current	100A	100A	100A	100A
Dimension	615*532*187mm	530*500*425mm	530*500*745mm	530*500*1065mm
Net weight	56KG	104KG	200KG	295KG

5.3 Interface Overview

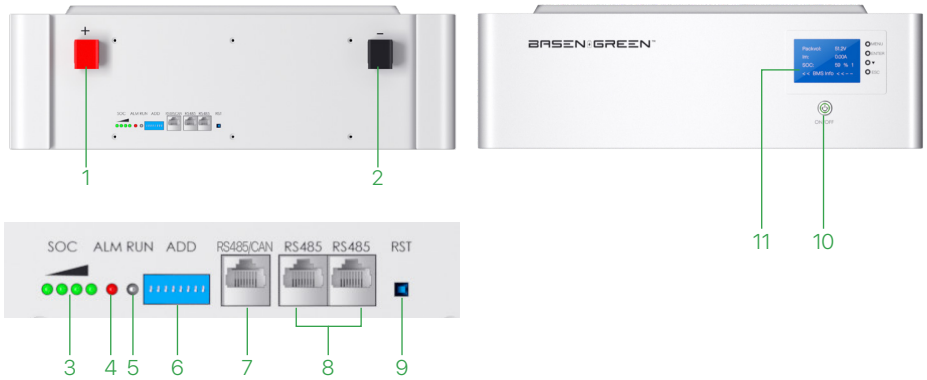

Position	Item	Description
1	P+	The positive terminal of the battery, can be connected to the positive pole of the inverter through a cable for DC output
2	P-	The negative terminal of the battery, can be connected to the negative pole of the inverter through a cable for DC output
3	SOC	4 indicators, indicating the remaining power status
4	Alarm	Indicating the abnormal state of the battery, if there is an low voltage or over voltage, the alarm will sound
5	RUN	Indicating the normal operation status of the battery
6	ADD	Setting up battery parallel communication and inverter communication
7	RS485/CAN	RS485/CAN port for the inverter or the upper system communication
8	RS485 B/C	RS485 port for parallel communication
9	RST	Manual-return switch button
10	Power switch	The switch for turn on/turn off the battery pack
11	LCD Screen	Display battery voltage, SOC, temperature, etc

5.4 Battery Management System (BMS)

5.4.1 Overcharge Protection

When the voltage of any single cell or whole battery pack is higher than the set value during the charging, and the duration reaches the limited time, the system enters the over charging protection state automatically, the charging MOS is turned off at the same time, and the battery cannot be charged. After the voltage of each cell and the whole battery pack drops below the cell over charging recovery value, the over charging protection state is released. It can also be released by discharging to return to normal state.

5.4.2 Overdischarge Protection

When the voltage of any single cell or whole battery pack is lower than the set value during discharging, and the duration reaches the limited time, the system enters the overdischarge protection state, the discharge MOS is turned off, and the battery cannot be discharged. After the overdischarge protection of the battery pack occurs, it can be released by charging the battery pack.

5.4.3 Overcurrent Protection

During charging and discharging, when the current exceeds the set value of the protection current, and the duration reaches the limited time, the system enters the overcurrent protection state, the charging and discharging MOS will be turned off automatically, and the battery cannot be charged and discharged, charging and discharging the battery pack can release the overcurrent protection state.

5.4.4 Over Temperature Protection

When the NTC detects the temperature of the battery cell surface is higher than the setting value of over temperature protection during charging and discharging, the management system enters the over temperature protection state, the charging or discharging MOS is turned off, and the battery pack cannot be charged or discharged in this state.

5.4.5 Low Temperature Protection

When the NTC detects that the temperature of the cell surface is lower than the setting value of low temperature protection during charging and discharging, the management system enters the low temperature protection state, the charging or discharging MOS is turned off, and the battery pack cannot be charged or discharged in this state.

6. Installation and configuration

6.1 Packing

a. After receiving the battery, open the box to check the battery surface if get any broken, crack,s or other bad phenomena; if get that, please do not install, and need to contact the supplier, and wait for the supplier's reply before proceeding to the next step.

b. Please ensure that the following items are included in the packaging:



Battery*1



M6*12mm
combination screws*2



Inverter
communication cable*1



Parallel
communication cable*1



Upper system
communication cable*1

C. The battery base is packed separately, each base is equipped with 4 horizontal adjustable universal wheels, customers can purchase the battery base according to the number of stacked packs, the load capacity of the base is 500KG, **support up to 8 units stacked.**



Support up to 8 units stacked

6.2 Installation Procedure

- Use a multi-meter to measure whether the positive and negative cable wires are conducting, and check whether the positive and negative terminal connections are loose.
- The battery should be switched off before wiring to ensure that there is no DC output from the battery.
- Connect positive terminals of the battery and the inverter with red power cable, and then connect negative terminals of both sides with black power cable.
- Connect both communication ports of the battery(RS485/CAN) and the inverter(BMS port) with the communication cable, BMS ports of inverter have different definition for some brands, pls check inverter manule.

Notice: The standard packing list does not include the parallel cable(positive and negative).

6.3 Installation Diagrams

Positive cable

Communication cable

Negative cable

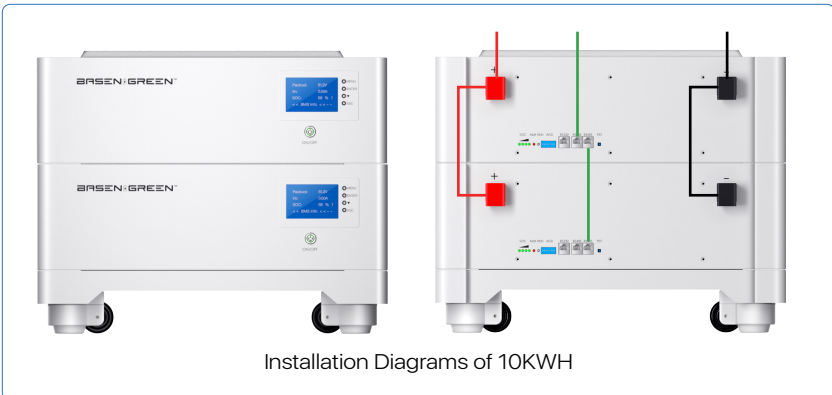
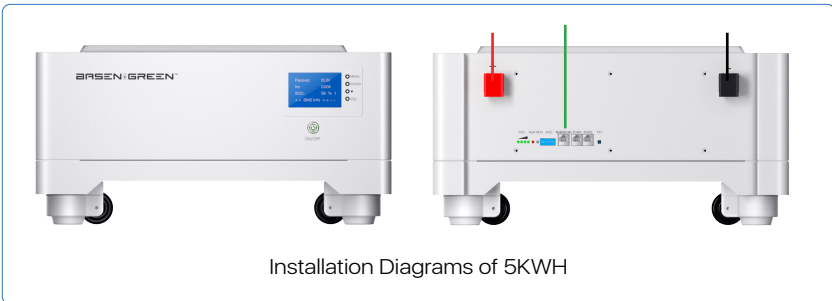

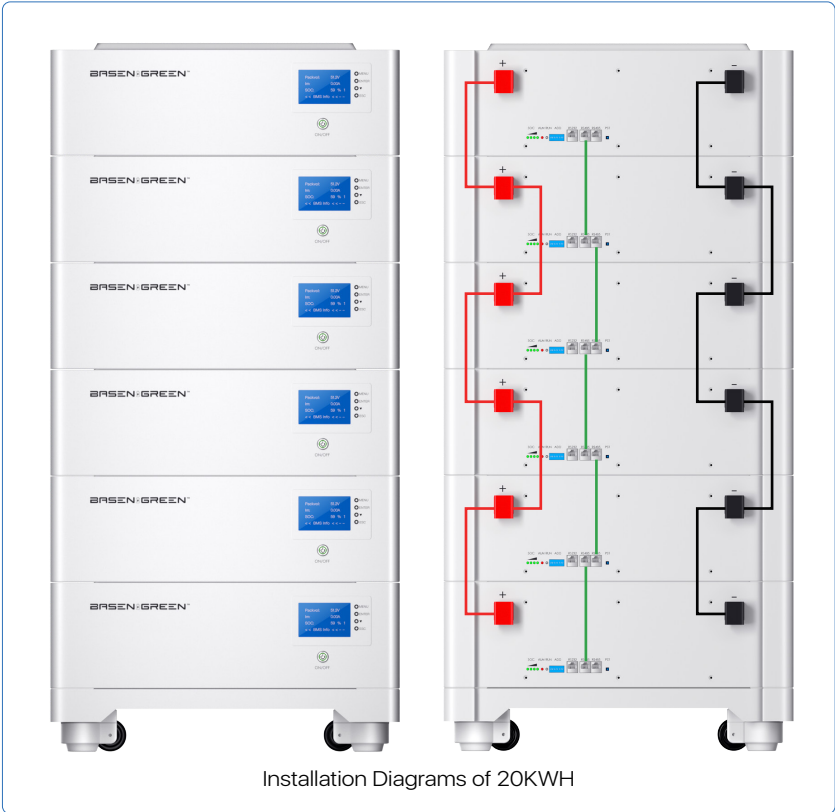
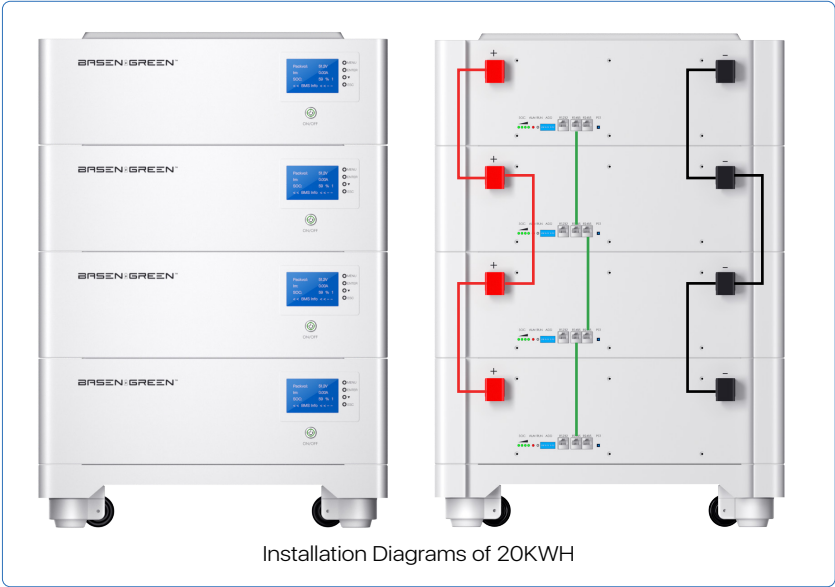

7. Connection

7.1 Precautions Before Connecting The Inverter

- Use a multi-meter to measure whether the positive and negative cable wires are conducting, and check whether the positive and negative terminal connections are loose.
- The battery should be switched off before wiring to ensure that there is no DC output from the battery.
- Connect positive terminals of the battery and the inverter with red power cable, and then connect-negative terminals of both sides with black power cable.
- The communication cable connects to the RS485/CAN port on the battery and then to the BMS port on the inverter.

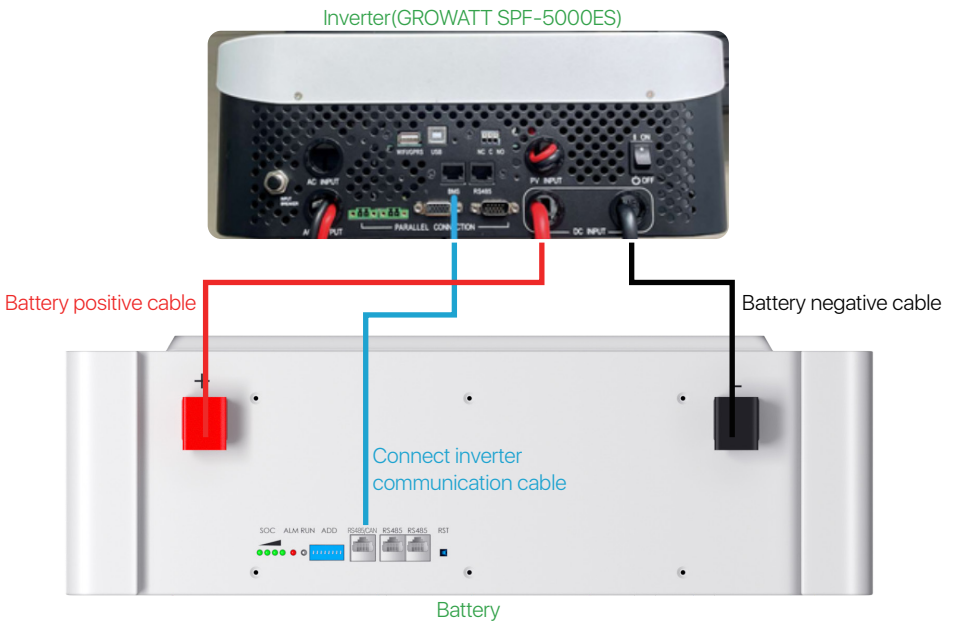

7.2 Pin Definition

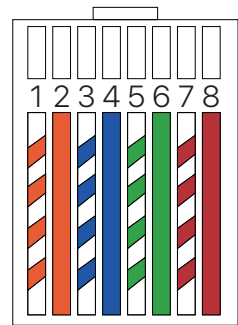
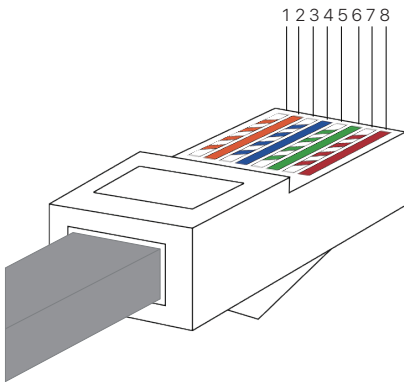
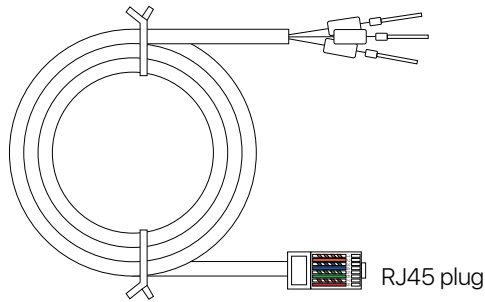

a. RS485/CAN Communication cable connection Pin definition is as follows:

PIN	1	2	3	4	5	6	7	8
Define	RS485-B	RS485-A	GND	CAN-H	CAN-L	GND	NC	NC

b. Parallel Communication cable connection Pin definition is as follows:

















PIN	1	2	3	4	5	6	7	8
Define	RS485-B	RS485-A	GND	NC	NC	GND	RS485-B	RS485-A

7.3 Dip Code Switch Definition and Setting

ADD switch is a 4-bit/8-bit DIP switch to manually distribute the communication address of parallel batteries.

The BMS will recognize the DIP address in a few seconds. When the DIP address is 0, the battery is configured as stand-alone working mode or master working mode; When the DIP address is 1 to 15, the BMS is configured as the slave working mode.

Please refer to the table below to set the DIP switch for parallel connection of different batteries.

8-BIT									
Address	Dip Switch Position								Illustration
	#1	#2	#3	#4	#5	#6	#7	#8	
0	OFF	OFF	OFF	OFF					
1	ON	OFF	OFF	OFF					
2	OFF	ON	OFF	OFF					
3	ON	ON	OFF	OFF					
4	OFF	OFF	ON	OFF					
5	ON	OFF	ON	OFF					
6	OFF	ON	ON	OFF					
7	ON	ON	ON	OFF					
8	OFF	OFF	OFF	ON					
9	ON	OFF	OFF	ON					
10	OFF	ON	OFF	ON					
11	ON	ON	OFF	ON					
12	OFF	OFF	ON	ON					
13	ON	OFF	ON	ON					
14	OFF	ON	ON	ON					
15	ON	ON	ON	ON					

8. Operation

8.1 Check Before Power on

- Check all positive, negative cables and communication lines are connected correctly and safely.
- Check the battery is firmly installed, easy to operate and maintain, and check ventilation.
- Insulate the unused ports.

8.2 Power on

- Turn on the switch on the battery.
- The green running LED is normal on (Check the status of the LED indicators)
- If it is failed to switch on the battery system, check if all the electrical connection is correct.
- If the electrical connection is correct, but the battery system is still unable to switch on, contact our after-sale service within 48 hours

LED Indicator Status

Status		Charging				Discharge			
Capacity Indicator		L1 ●	L2 ●	L3 ●	L4 ●	L1 ●	L2 ●	L3 ●	L4 ●
Battery Level	0~25%	Flash	OFF	OFF	OFF	Light	OFF	OFF	OFF
	25~50%	Light	Flash	OFF	OFF	Light	Light	OFF	OFF
	50~75%	Light	Light	Flash	OFF	Light	Light	Light	OFF
	≥75%	Light	Light	Light	Flash	Light	Light	Light	Light
Normal Status Indicator ●		Light				Flash			

Flashing Definition

Item	Light	OFF
Flash 1	0.25 s	3.75 s
Flash 2	0.5 s	0.5 s
Flash 3	0.5 s	1.5 s

LED Flashing Faulty

Status	Normal/warning/ protection	RUN	ALM	Battery capacity LED				Specification
		●	●	●	●	●	●	
Power off	Sleep	OFF	OFF	ALL OFF				
Stand by	Normal	Light	OFF	ALL OFF				
Charging	Normal	Light	OFF	Display according to the actual SOC				
	Over Current Alarm	Light	Flash 2					
	Over Voltage Protection	Flash 1	OFF	ALL OFF				
	Over temperature /Over Current Protection	Flash 1	Flash 1	ALL OFF				
Discharge	Normal	Flash 3	OFF	Display according to the actual SOC				
	Alarm	Flash 3	Flash 3					
	Temperature/ Over Current /Short circuit Protection	OFF	Light	ALL OFF				Cut-off Discharge
	Low Voltage Protection	OFF	OFF	ALL OFF				Cut-off Discharge

9. Operation of Upper System

BASEN 48V battery pack supports to connect with our upper system to monitor the status of the battery and modify the communication protocol, please contact our sales representative or visit our website to get the latest upper system software.

9.1 Log in

- The upper system communication cable connects to the RS485 port on the battery and then to the USB port on the PC/Laptop
- Download and open the upper system software
- Modify the language
- Updated the status of battery automatically

Notice: If it is failed to connect to the upper system, check if all the connection is correct. If the connection is correct, but the upper system is still unable to work, please contact our after-sale service



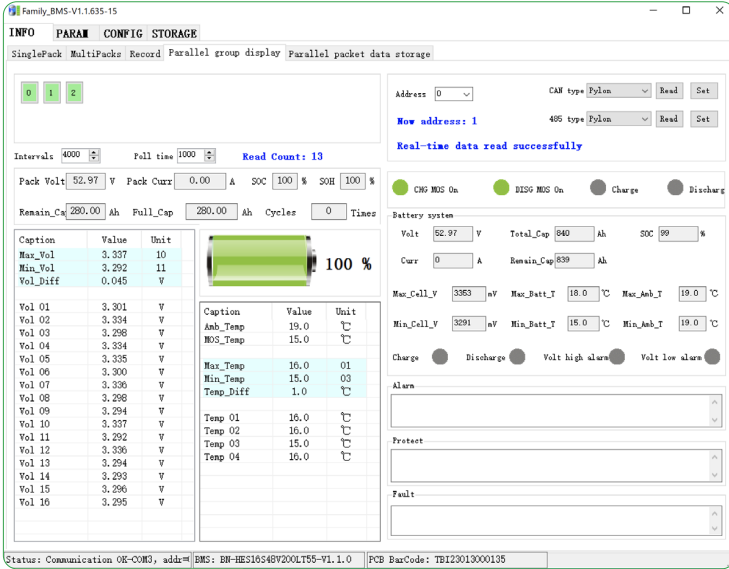

9.2 Operation of The Communication Protocol Switch

Connect to the upper system and follow the path:

INFO—Parallel Group Display—CAN Type/RS485 Type—Read—Choose the protocol—Set

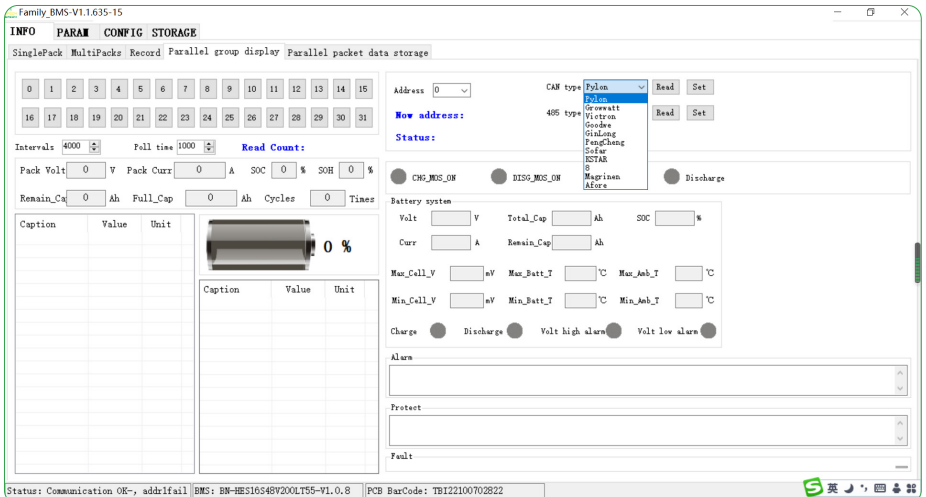

9.3 Communication Compatible List

BASEN BMS Inverter Communication Protocol Matching Table					
Inverter Brand	Communication method	Protocol Name	Protocol Remarks	Communication Potter rate	Interface Definition
维克托-Victron 	CAN	Victron-CAN-V1.00- 211135	Active Upload	500K	7H、 8L
古瑞瓦特-SPF Growatt-SPF 	485	Growatt BMS-RS485-protocol-1x30xP_ESSL_V2.01 Growatt BMS-RS485-protocol-V2.0	MODBUS Standard protocols	9600	1B、 2A
古瑞瓦特-SPF Growatt-SPF 	CAN	Growatt BMS CAN-Bus-protocol-low-voltage-V1.05	Active Upload	500K	4H、 5L
古瑞瓦特-SPH Growatt-SPF 	CAN	Growatt BMS communication protocol of growatt low voltage-V1.01	Active Upload	500K	4H、 5L
德业 Deye 	CAN	Deye LV-CAN communication protocol	Active Upload	500K	4H、 5L
德业 Deye 	485	485 Modbus Protocol(4)-deye	MODBUS protocols	9600	1B、 2A
尚科-Solar 	CAN	Growatt BMS CAN-Bus-protocol-low-voltage-V1.05	Active Upload	500K	4H、 5L
固德威-Goodwe 	CAN	Goodwe-CAN-V1.7-220228-SolarinverterFamily-EN	Active Upload	500K	4H、 5L
日月元-Voltronic Power 	485	Voltronic Power-485-V1.03-200325	MODBUS protocols	9600	3B、 5A
首航-SOFAR 	CAN	SOFAR-CAN-V1.00-211117-Rev6	Active Upload	500K	1H、 2L
锦浪-Solis 	CAN	Solis-CAN-V1.0-191228-lowVoltage	Active Upload	500K	4H、 5L
鹏城-Luxpower 	CAN	Luxpowertek Battery CAN Protocol -2021	Active Upload	500K	4H、 3L
派能-Pylontech 	485	Pylon-485-V3.5-161216-low voltage protocol	1363	115200	1B、 2A
派能-Pylontech 	485	Pylon-485-V3.5-161216-low voltage protocol	1363	9600	1B、 2A
派能-Pylontech 	CAN	Pylon-CAN-V1.2- 180408 -lowVoltage	Active Upload	500K	4H、 5L
硕日-Srne 	485	shuori BMS Modbus Protocol for RS485 V1.3(2020-11-24)	MODBUS	9600	7A、 8B
美世乐 Must 	CAN	PV1800F-CAN communication Protocol1.04.04	Active Upload	100K	6H、 5L
艾思玛 SMA 	CAN	SMA-CAN-V1.0.0-210630-FSS -ConnectingBat-Ti-en-20W	Active Upload	500K	4H、 5L
阳光电源 SUNGROW 	CAN	Pylon-CAN-V1.2- 180408 -lowVoltage	Active Upload	500K	4H、 5L
爱士惟 AISWEI 	CAN	Pylon-CAN-V1.2- 180408 -lowVoltage	Active Upload	500K	4H、 5L
英威腾 INVT 	CAN	Pylon-CAN-V1.2- 180408 -lowVoltage	Active Upload	500K	4H、 5L
科士达 KSTAR 	CAN	Kstar CAN_Protocol-V1.11	Active Upload	500K	4H、 5L
艾伏 Afore 	CAN	Afore Communication Protocol CAN Bus Version V1.02_20210104	Active Upload	500K	4H、 5L
索瑞德-SOROTEC 	CAN	CAN Protocol 1.0(SOROTEC Protocol)	MODBUS Standard protocols	500K	4H、 5L
索瑞德 SOROTEC 	485	Protocol between Sorotec Inverter and Lithium Battery (RS485)	Active Upload	500K	1B、 2A
SOL-ARK 	CAN	Sol-Ark CAN Bus Protocol V1.2.pdf4-25-22		500K	4H、 5L
迈格瑞能 MEGAREVO 	CAN	Shenzhen MEGAREVO Hybrid Inverter-5K BMS Protocol V1.01	Active Upload	500K	4H、 5L
MPP Solar 	485	BMS 485 communication protocol 20200325(2)	MODBUS	9600	1B、 2A
拓宝-TBB 	CAN	CAN BUS Protocol of TBB Lithium Battery BMS Platform V 1.1	Active Upload	500K	4H、 5L
盛能杰-Senergy 	CAN	SenergyINV&BMS_CAN_Protocols	Active Upload		4H、 5L

10. Storage

- a. External terminals of the battery pack are insulated and protected.
- b. If the battery pack is stored for a long period of time without use, it is recommended that it be charged 30%-60%, and it is prohibited to store it completely uncharged.
- c. Batteries that have been in storage for more than 3 months should be recharged for 2-3 hours at 0.2C~0.3C.
- d. Batteries should be stored in a dry, clean, ventilated, non-corrosive gas environment, away from sources of ignition, to avoid exposure to the sun.
- e. Do not store or put in high temperatures over 60°C for a long period of time, otherwise, it will cause function deterioration and life span reduction.

11. Warning

To prevent possible battery leakage, heat generation, and explosion, please observe the following warning:

Warning!

- a. It is strictly forbidden to immerse the battery in seawater or water. When not in use, it should be placed in a cool and dry environment;
- b. It is strictly forbidden to reverse the positive and negative poles to use the battery;
- c. It is forbidden to use metal to directly connect the positive and negative electrodes of the battery to a short circuit;
- d. It is forbidden to transport or store batteries together with metals, such as hairpins, necklaces, etc;
- e. It is forbidden to knock or throw, step on the battery, etc.;
- f. It is forbidden to directly weld the battery and pierce the battery with nails or other sharp objects.

Attention!

- a. It is forbidden to use or place the battery under high temperatures (in the hot sun or in a very hot car), otherwise, it may cause the battery to overheat, catch fire or fail to function, and shorten its life; the recommended temperature for long-term battery storage is 10–45°C;
- b. It is forbidden to throw batteries into fires or heaters to prevent fire, explosion, and environmental pollution. Scrapped batteries should be returned to the supplier or battery recycling point for disposal;
- c. Do not use it in places with strong static electricity and strong magnetic fields, otherwise it will easily damage the battery safety protection device and bring unsafe hidden dangers;
- d. If the battery leaks and the electrolyte enters the eyes, do not rub it. Immediately rinse the eyes with clean water and send them to the hospital for treatment, otherwise, the eyes will be hurt. If the battery emits an odor, heats up, discolors, deforms, or has any abnormality during use, storage, or charging, immediately remove the battery from the device or charger and stop using it;
- e. It is forbidden to insert the positive and negative poles of the battery directly into the power socket, and a special charger for lithium-ion batteries must be used;
- f. Check the battery voltage and connectors before installation, and use it only after everything is normal;
- g. The battery is stored in half power. If the battery has not been used for three months, it needs to be recharged once;
- h. If the electrode is dirty, it should be wiped with a dry cloth before use. Otherwise, it may cause poor contact and function failure;

Need additional information?

Just Contact BASEN!

BASEN  GREEN

BASENGREEN
YOUR RELIABLE POWER



Fax: (+86)0755-84737145



Tex: (+86)130 0887 9993



Email: info@Basengroup.com



Shenzhen Basen Technology Co., Ltd.



Add: Room 303, Building 3, 1980 Culture and Technology Industrial Park,
Donghuan Road, Longhua District, Shenzhen